

# ASSEMBLY INSTRUCTION

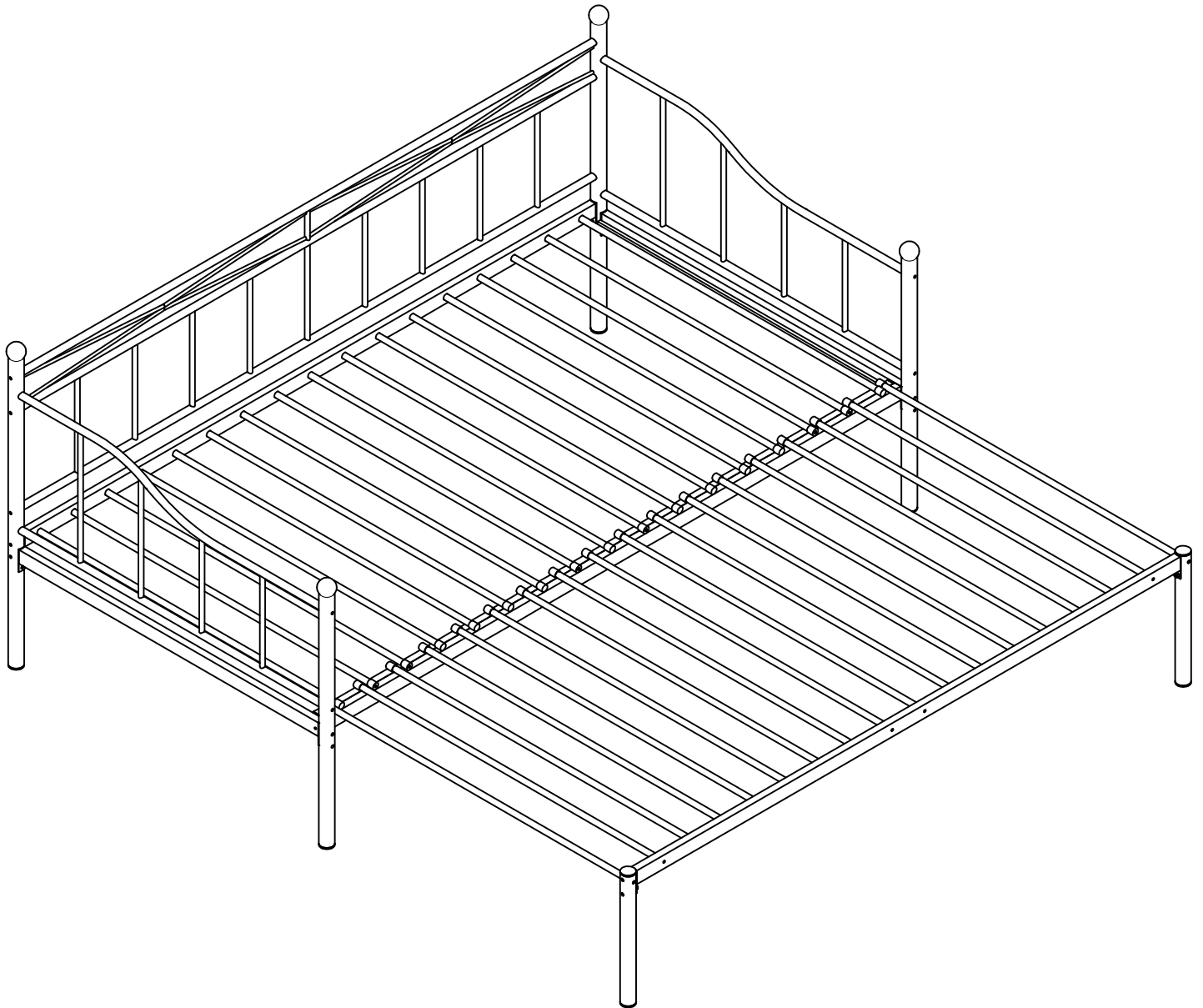

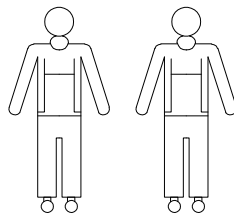

MF296383AAB/AAK/AAH





Minimum no. 2 of people  
recommended to assemble  
this product: Approx.  
assembly time: 60 mins

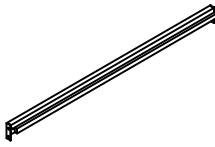
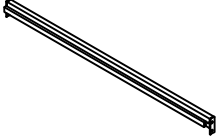
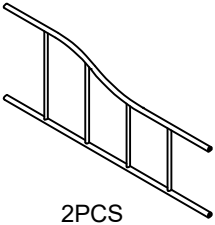
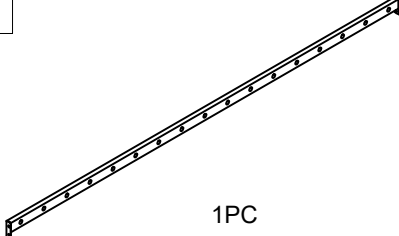
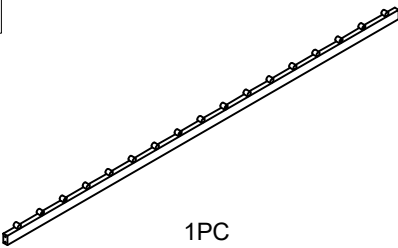
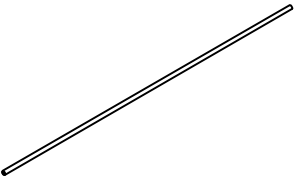
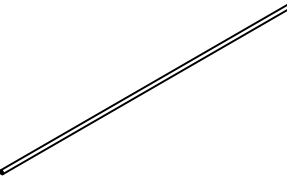
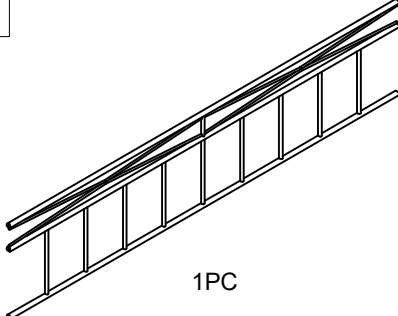

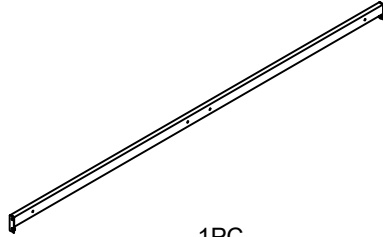
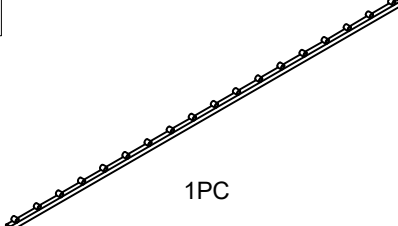
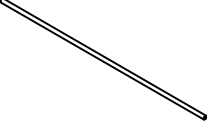
# PART LIST

<p>1</p>  <p>2PCS</p>	<p>2</p>  <p>2PCS</p>	<p>3</p>  <p>1PC</p>
<p>4</p>  <p>1PC</p>	<p>5</p>  <p>2PCS</p>	<p>6</p>  <p>1PC</p>
<p>7</p>  <p>1PC</p>	<p>8</p>  <p>23PCS</p>	<p>9</p>  <p>10PCS</p>
<p>10</p>  <p>1PC</p>	<p>11</p>  <p>2PCS</p>	<p>12</p>  <p>1PC</p>
<p>13</p>  <p>1PC</p>	<p>14</p>  <p>2PCS</p>	

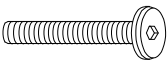
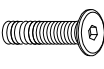

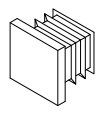
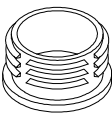
# HARDWARE LIST

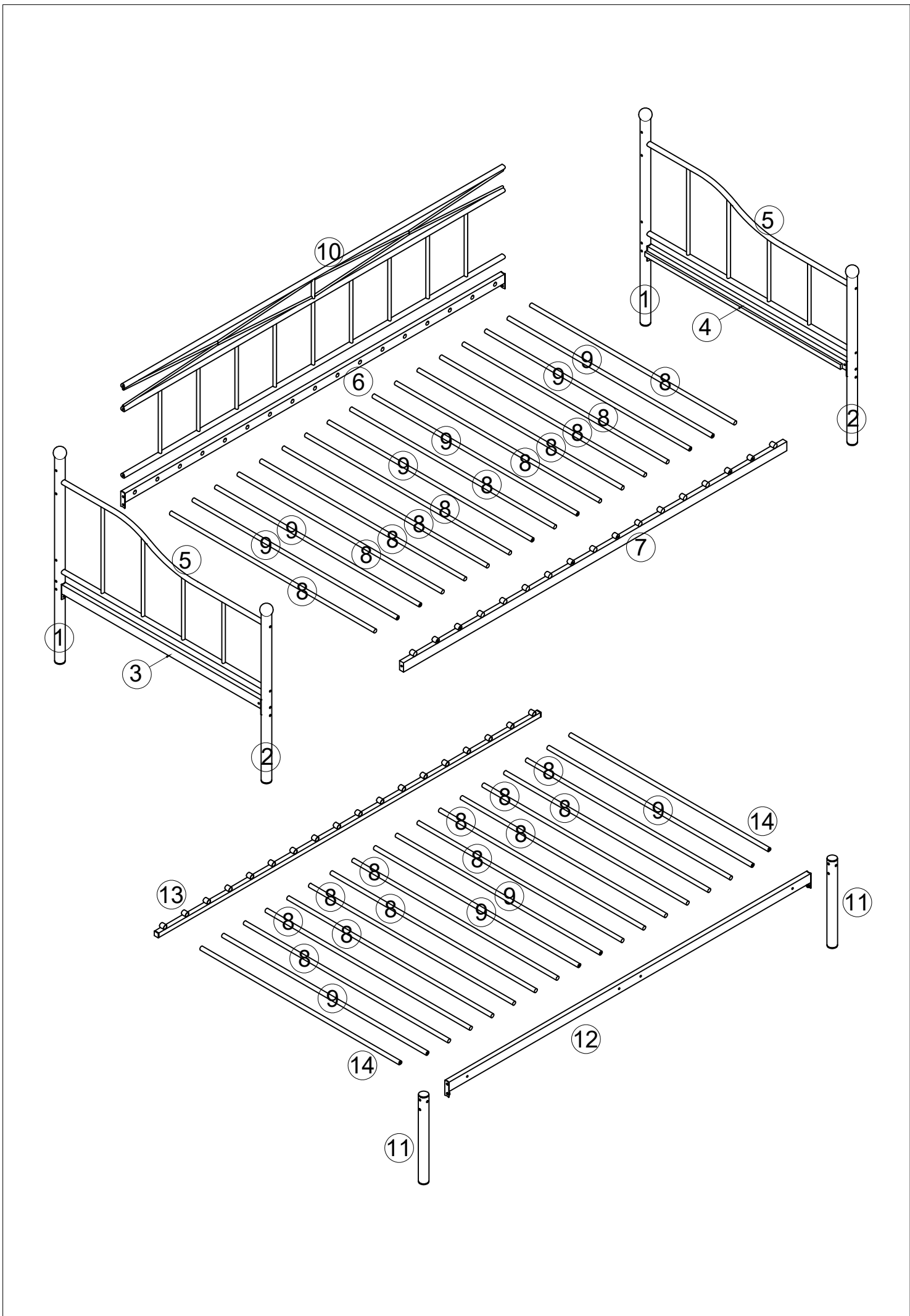
<p>A</p>  <p>34PCS M<math>\frac{1}{4}</math>"X45</p>	<p>B</p>  <p>22PCS M<math>\frac{1}{4}</math>"X15</p>	<p>C</p>  <p>1PC M4X23X57</p>	<p>D</p>  <p>2PCS foot nail #20x20</p>
<p>E</p>  <p>8PCS foot nail Ø38x20</p>			



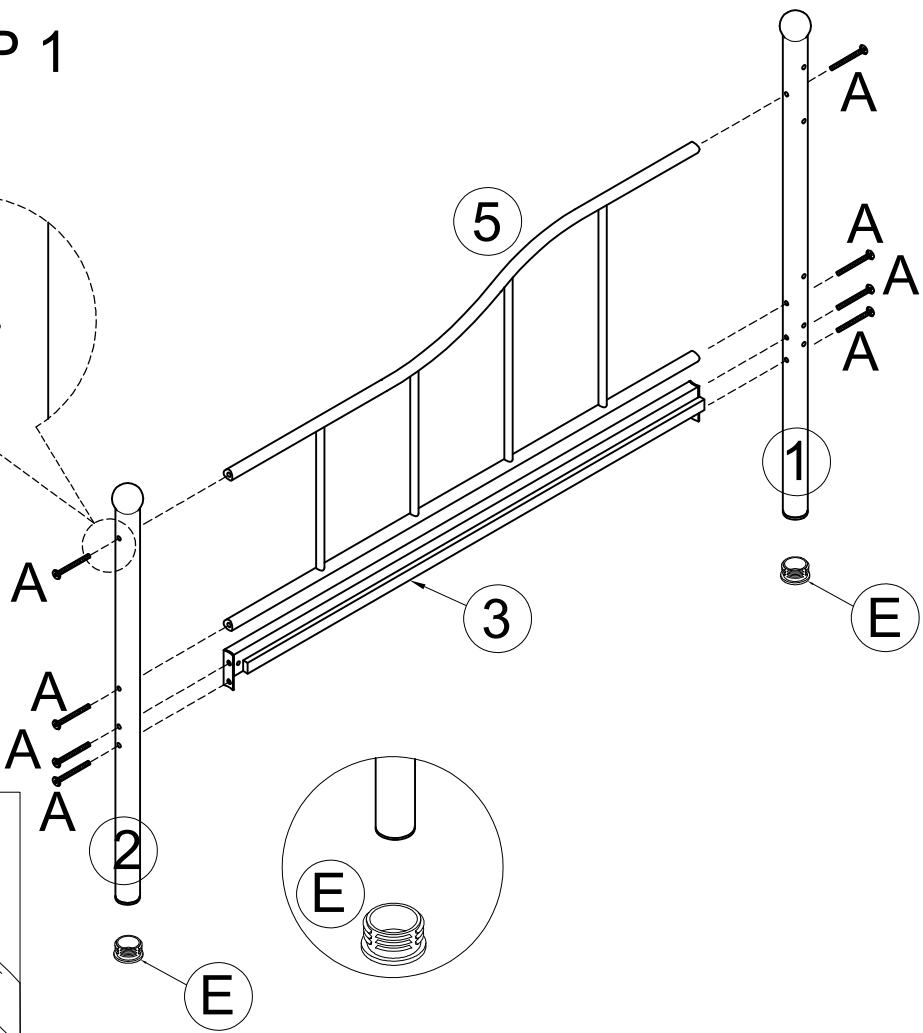
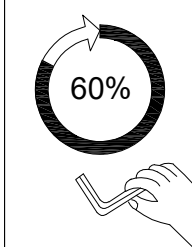
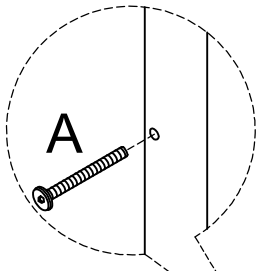

# STEP 1

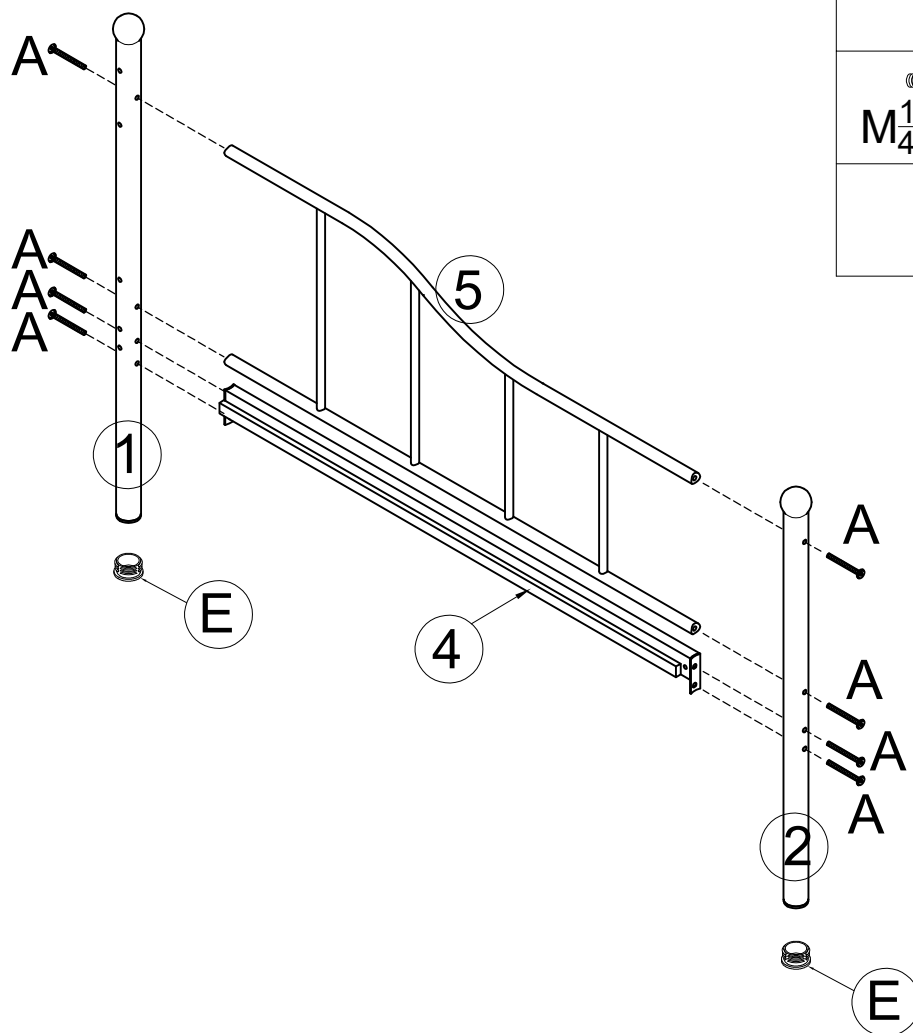
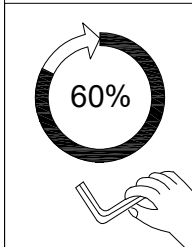

A	E
 M $\frac{1}{4}$ 'x45	 Ø38x20
8	2

# STEP 2



A	E
 M $\frac{1}{4}$ 'x45	 Ø38x20
8	2

### STEP 3

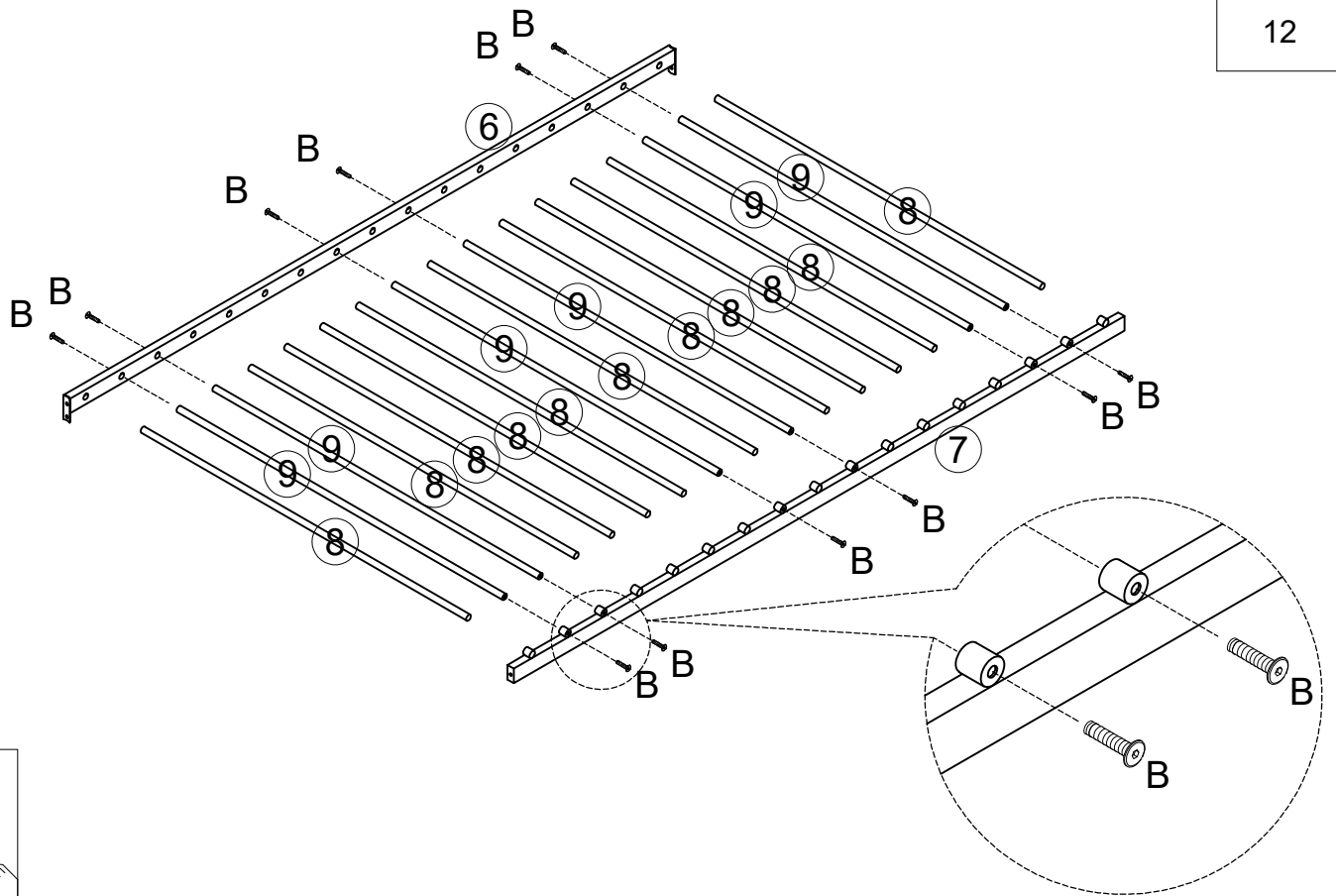

B

  
M $\frac{1}{4}$ "x15

12



### STEP 4

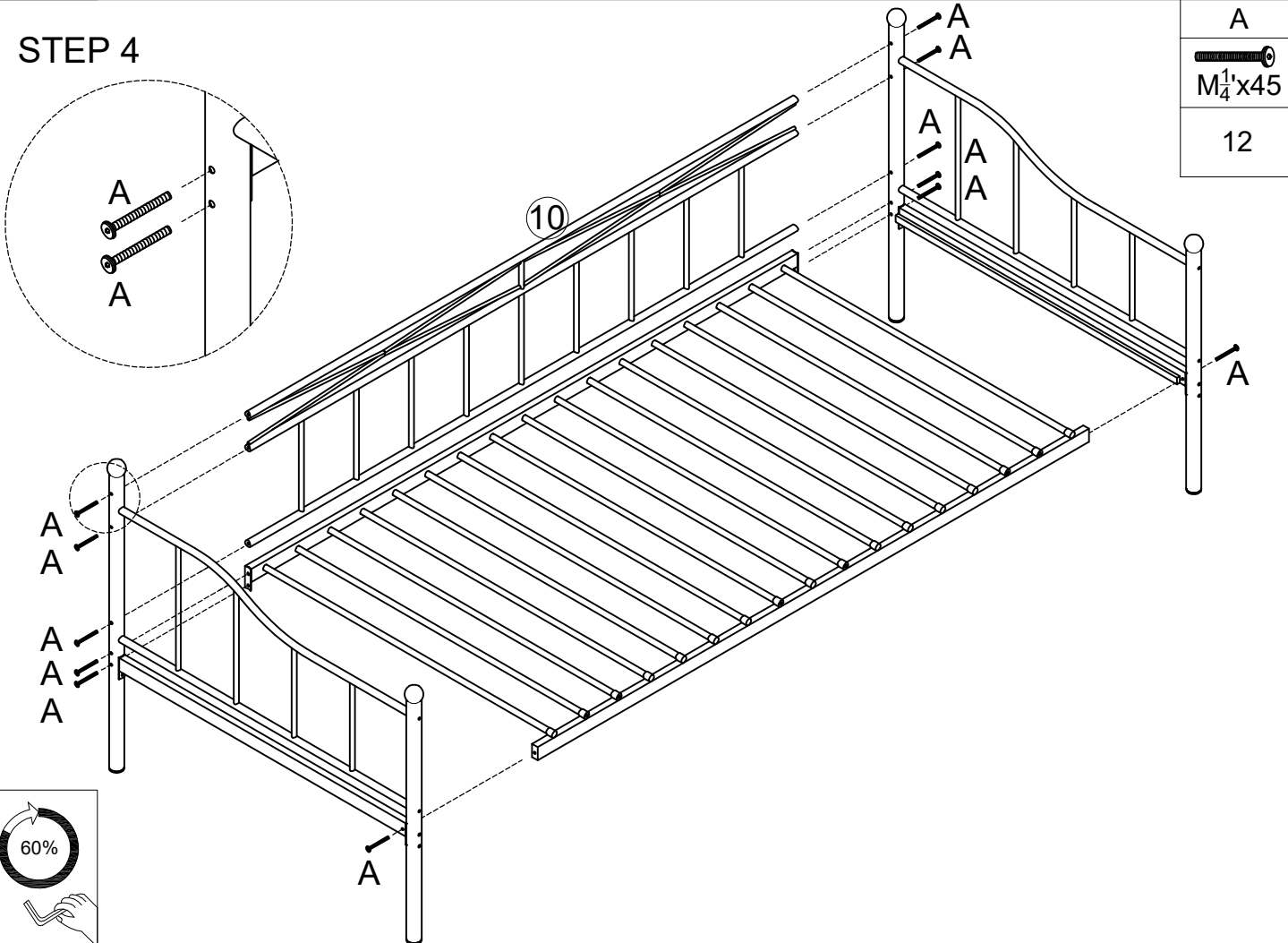



A

  
M $\frac{1}{4}$ "x45

12



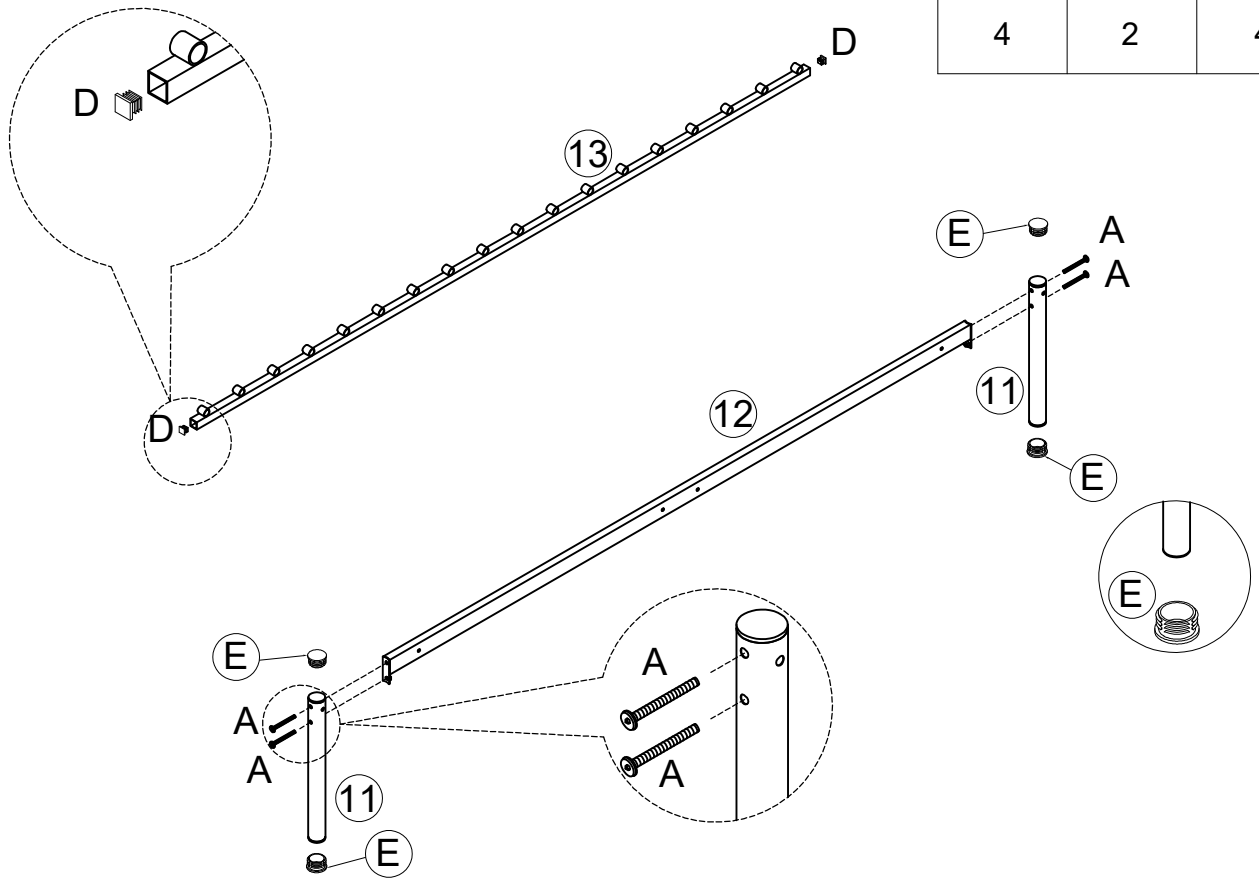

# STEP 5

A	D	E
 M $\frac{1}{4}$ "x45	 #20x20	 Ø38x20
4	2	4



# STEP 6

A	B
 M $\frac{1}{4}$ "x45	 M $\frac{1}{4}$ "x15
2	10

