

ASSEMBLY INSTRUCTIONS

WF297945

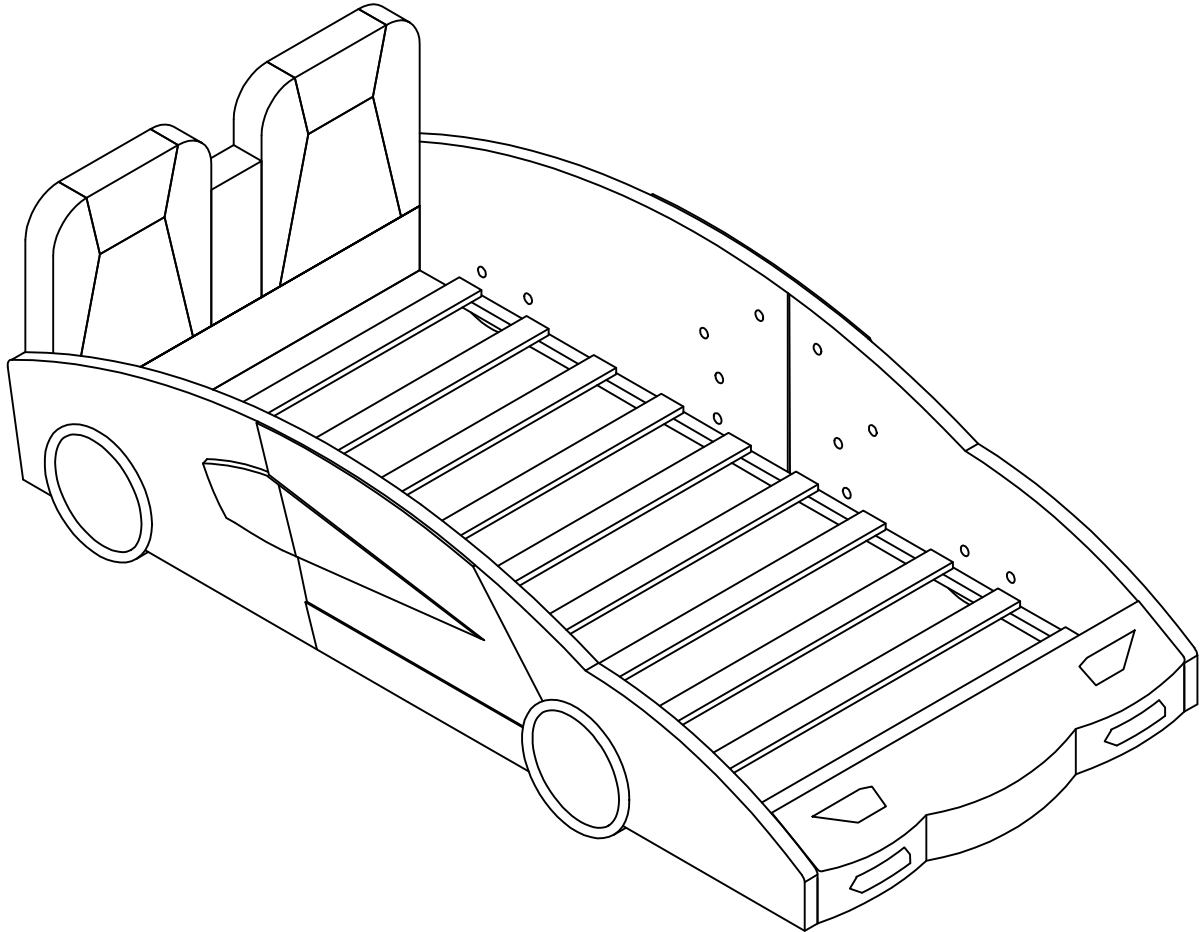

IMPORTANT NOTE

****PLACE ALL PARTS ON A CLEAN AND SMOOTH SURFACE SUCH AS A RUG OR CARPET TO AVOID THE PARTS FROM BEING SCRATCHED**



**** BEFORE YOU BEGIN , KINDY FOLLOW THE ASSEMBLY INSTRUCTIONS STEP BY STEP**

****DO NOT TIGHTEN ALL SCREWS AND BOLTS UNTIL THE BED IS FULLY SET-UP**

ASSEMBLY INSTRUCTIONS

WF297945

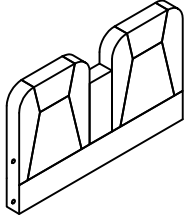

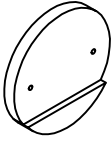
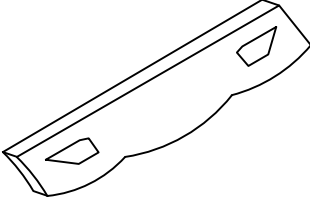
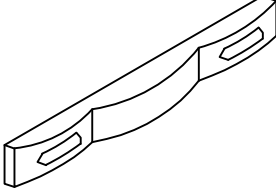
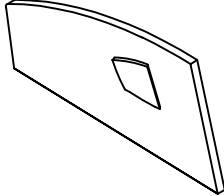
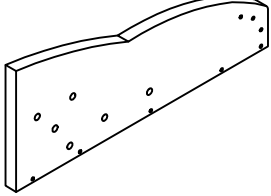
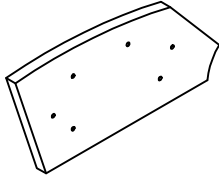
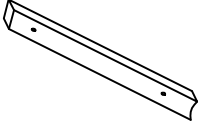
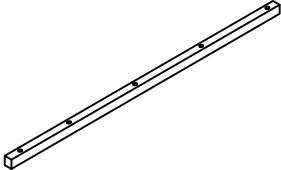
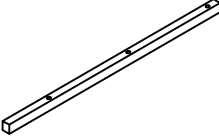
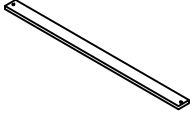

PART LIST BOX 1: WF 297945

<p>1</p>  <p>Headboard Panel (1 pc)</p>	<p>2</p>  <p>Headboard Connector (1 pc)</p>	<p>3</p>  <p>Leg (4 pcs)</p>
<p>4</p>  <p>Footboard Top Panel (1 pc)</p>	<p>5</p>  <p>Footboard Bottom Panel (1 pc)</p>	<p>6</p>  <p>Side Rail Front Panel (2 pcs)</p>
<p>7</p>  <p>Side Rail Back Panel (2 pcs)</p>	<p>8</p>  <p>Side Rail Big Support (2 pcs)</p>	<p>9</p>  <p>Side Rail Small Support (2 pcs)</p>
<p>10</p>  <p>Side Rail Long Support (2 pcs)</p>	<p>11</p>  <p>Side Rail Short Support (2 pcs)</p>	<p>12</p>  <p>Roll Slat (10 pcs)</p>

ASSEMBLY INSTRUCTIONS

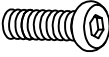
WF297945

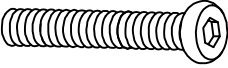
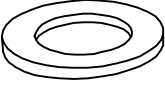

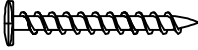
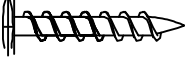
HARDWARE LIST IN WF297945

<p>A</p>  <p>Short Bolt (24pcs) (Ø 5/16 "X25mm)</p>	<p>B</p>  <p>Short Bolt (8pcs) (Ø 5/16 "X20mm)</p>	<p>C</p>  <p>Long Bolt (5 pcs) (Ø 5/16 "X32mm)</p>
<p>D</p>  <p>Long Bolt (16pcs) (Ø 5/16 "X45mm)</p>	<p>E</p>  <p>Flat Washer (53 pcs) (Ø 5/16 " -RBW)</p>	<p>F</p>  <p>Allen Wrench (1 pc) (M4x75mm x32mm)</p>
<p>G</p>  <p>Flat Head Screw (20 pcs) (m4x30mm-RBW)</p>	<p>H</p>  <p>Flat Head Screw (6 pcs) (m4x15mm-RBW)</p>	

ASSEMBLY INSTRUCTIONS

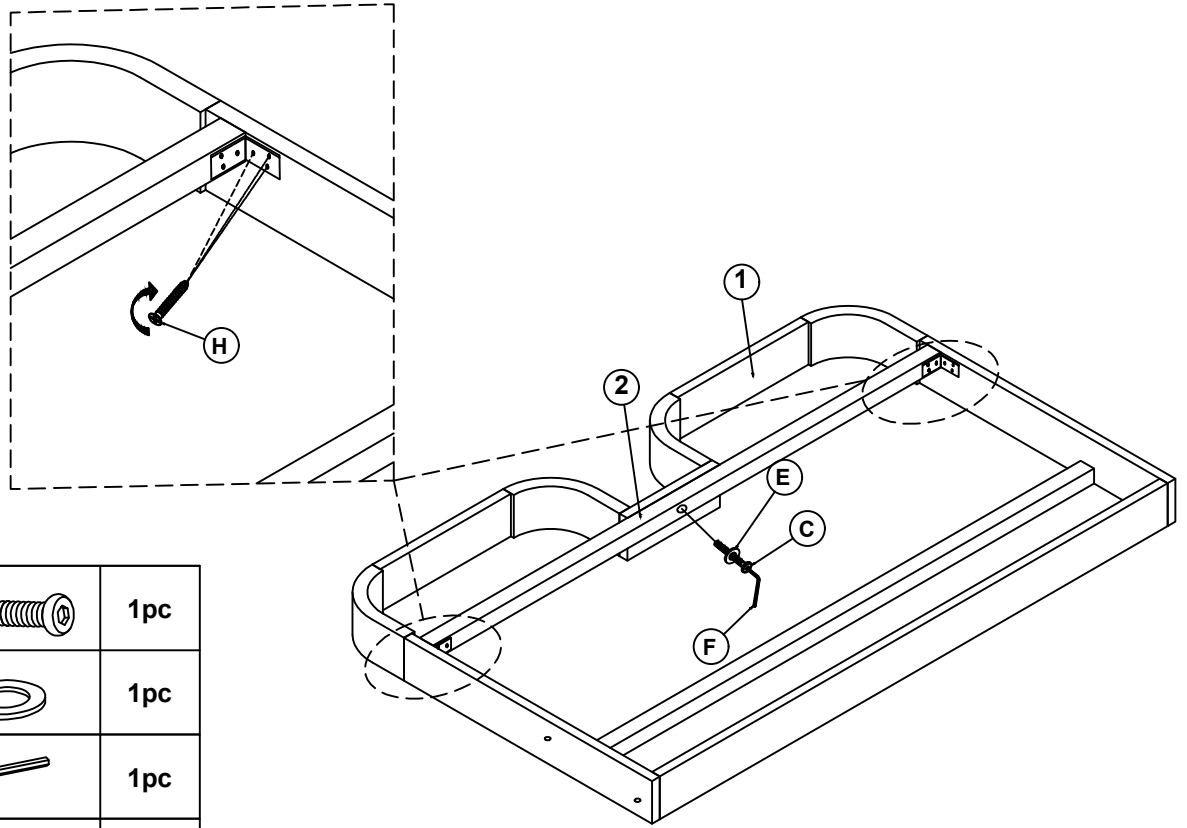

STEP 1

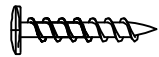

C	Bolt (Ø 5/16 "X32mm)		1pc
E	Flat Washer (Ø 5/16 " -RBW)		1pc
F	Allen Wrench (M4x75mm x32mm)		1pc
H	Flat Head Screw (m4x15mm-RBW)		6pcs

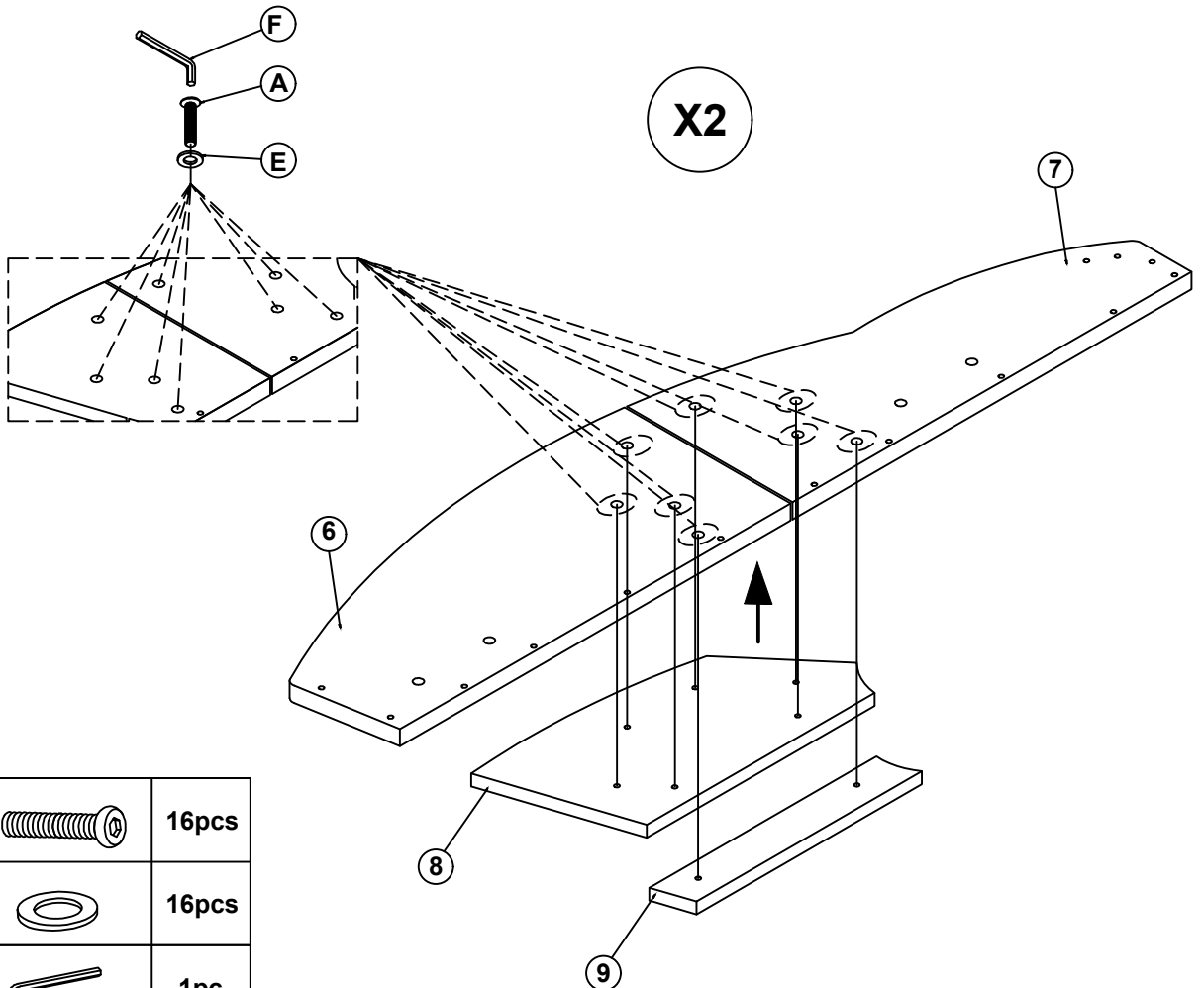
STEP 2





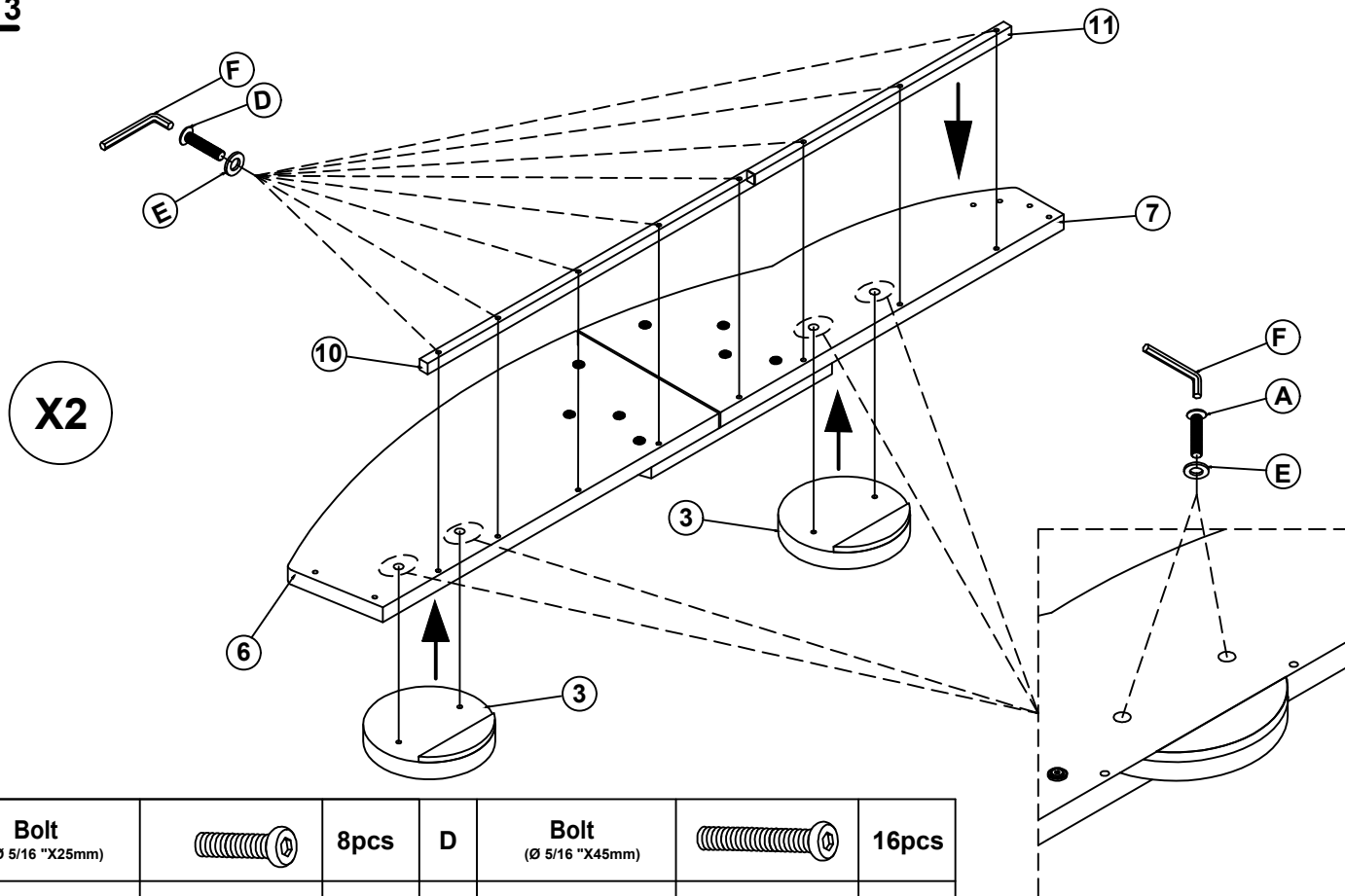

A	Bolt (Ø 5/16 "X25mm)		16pcs
E	Flat Washer (Ø 5/16 " -RBW)		16pcs
F	Allen Wrench (M4x75mm x32mm)		1pc

ASSEMBLY INSTRUCTIONS

STEP 3



A	Bolt (Ø 5/16 "X25mm)		8pcs	D	Bolt (Ø 5/16 "X45mm)		16pcs
E	Flat Washer (Ø 5/16 "RBW)		24pcs	F	Allen Wrench (M4x75mm x32mm)		1pc



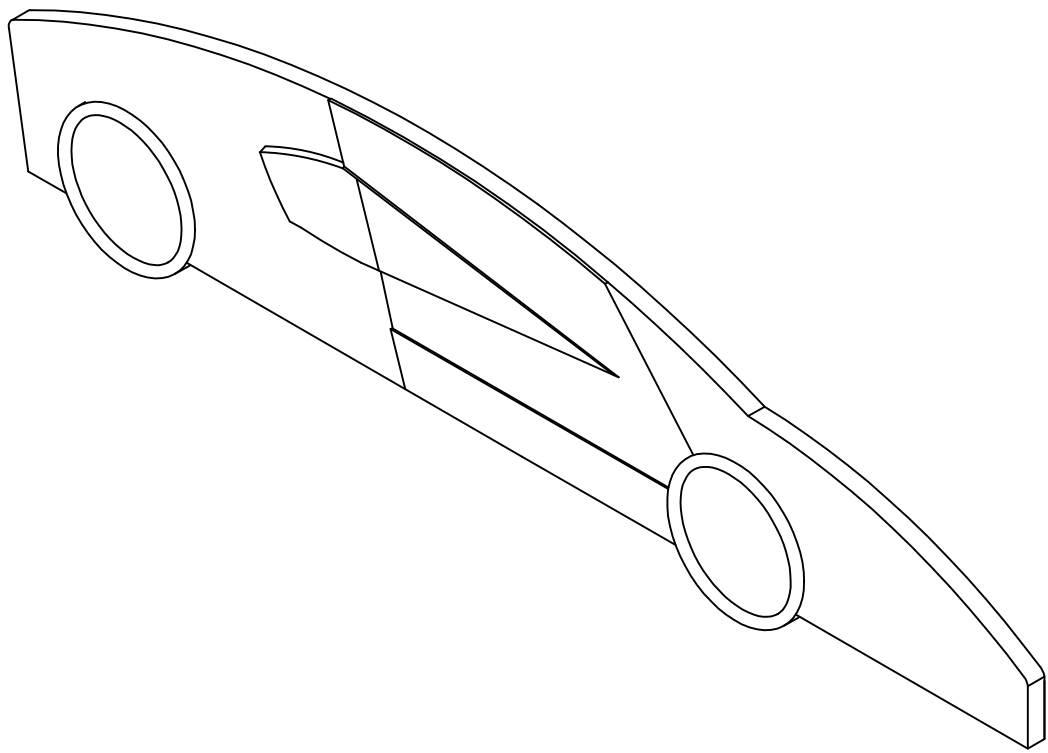

STEP 4

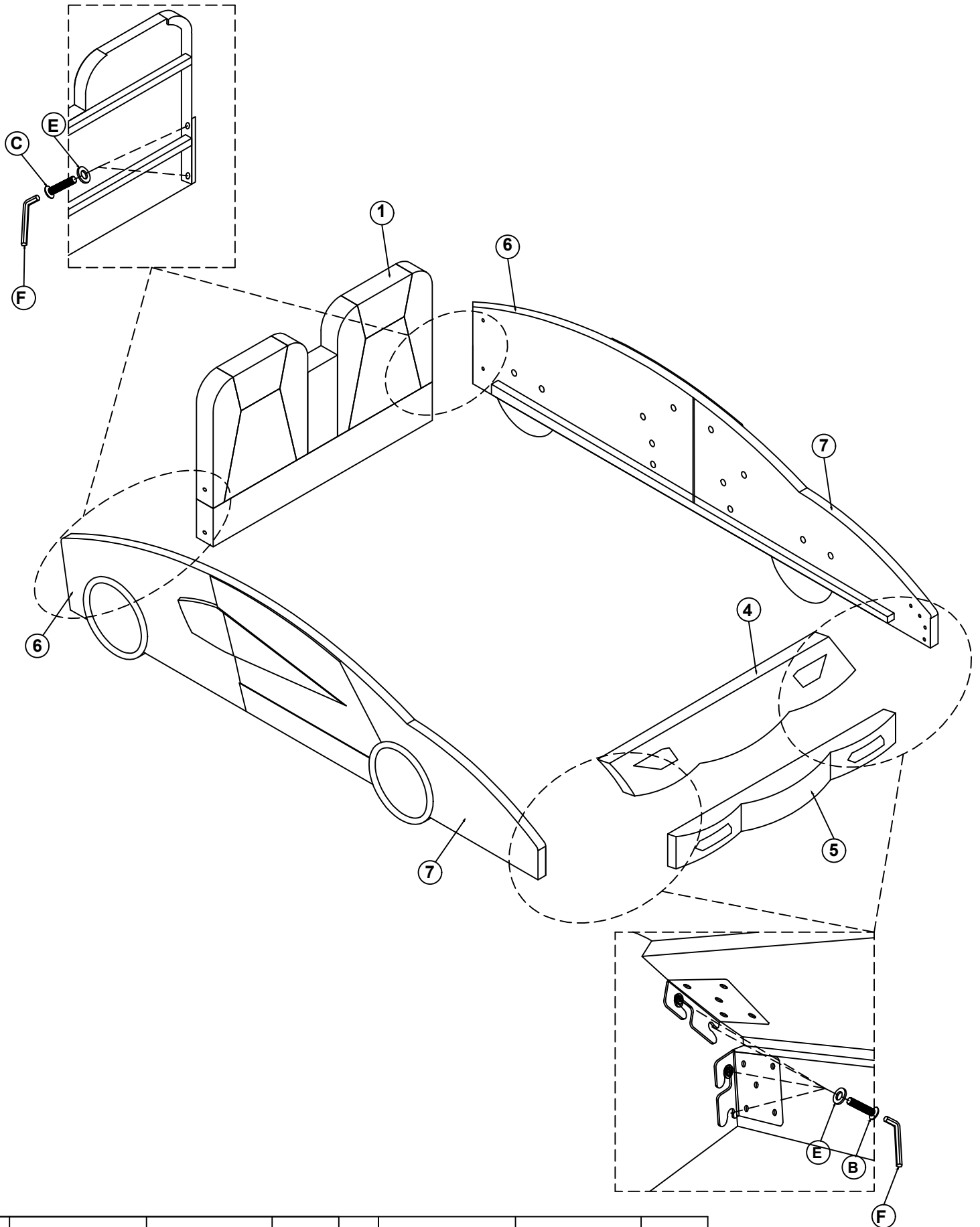

ASSEMBLY INSTRUCTIONS

STEP 5



B	Bolt (Ø 5/16 "X20mm)		8pcs	C	Bolt (Ø 5/16 "X32mm)		4pcs
E	Flat Washer (Ø 5/16 "RBW)		12pcs	F	Allen Wrench (M4x75mm x32mm)		1pc

ASSEMBLY INSTRUCTIONS

STEP 6

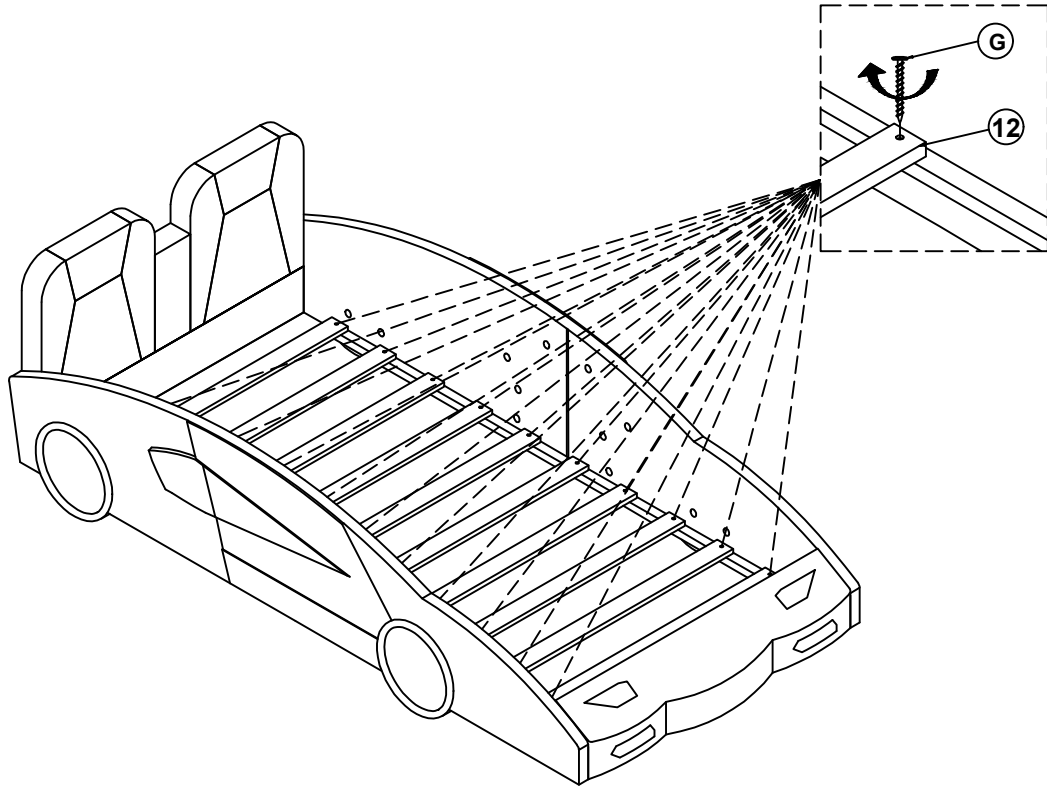

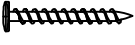
G	Flat Head Screw (m4x30mm-RBW)		20pcs
---	----------------------------------	---	-------

STEP 7

COMPLETE

